

INFRARED GAS HEATER

VAL6

GN5 GP5



Owner's Manual

IMPORTANT

- This Owner's Manual provides important information on proper handling, operation, and maintenance. FAILURE TO FOLLOW THE INSTRUCTIONS, PRECAUTIONS, OR SAFETY TIPS IN THIS MANUAL AUTOMATICALLY VOIDS ALL WARRANTIES, EXPRESS OR IMPLIED.
- FAILURE TO COMPLY WITH THE INSTRUCTIONS, PRECAUTIONS, AND SAFETY TIPS IN THIS MANUAL CAN RESULT IN DEATH, SERIOUS BODILY INJURY AND PROPERTY LOSS OR DAMAGE FROM HAZARDS OF FIRE, EXPLOSION, BURN, ASPHYXIATION, CARBON MONOXIDE POISONING, AND / OR ELECTRICAL SHOCK.
- Read and thoroughly understand this Owner's Manual before using the heater in any way, including unpacking, assembling, fueling, inspecting, lighting, operating, adjusting, turning off, cooling down, moving, or storing the heater.
- Please keep this Manual for the user's need and reference .
- Do not allow anyone who has not read and understood this Owner's Manual to assemble, inspect, light, operate, adjust, turn off, cool down, refuel, move, or store the heater.
- The requirements of local authorities having jurisdiction shall be followed.
- The installation of the unit shall be in accordance with the regulations of the authorities having jurisdiction.



 **GENERAL HAZARD WARNING:**

FAILURE TO COMPLY WITH THE PRECAUTIONS AND INSTRUCTIONS PROVIDED WITH THIS HEATER, CAN RESULT IN DEATH, SERIOUS BODILY INJURY AND PROPERTY LOSS OR DAMAGE FROM HAZARDS OF FIRE, EXPLOSION, BURN, ASPHYXIATION, CARBON MONOXIDE POISONING, AND / OR ELECTRICAL SHOCK.

ONLY PERSONS WHO CAN UNDERSTAND AND FOLLOW THE INSTRUCTIONS SHOULD USE OR SERVICE THIS HEATER.

IF YOU NEED ASSISTANCE OR HEATER INFORMATION SUCH AS AN INSTRUCTIONS MANUAL, LABEL, ETC. CONTACT THE MANUFACTURER.

 **WARNING:** FIRE, BURN, INHALATION, AND EXPLOSION HAZARD. KEEP SOLID COMBUSTIBLES, SUCH AS BUILDING MATERIALS, PAPER OR CARDBOARD, A SAFE DISTANCE AWAY FROM THE HEATER AS RECOMMENDED BY THE INSTRUCTIONS. NEVER USE THE HEATER IN SPACES WHICH DO OR MAY CONTAIN VOLATILE OR AIRBORNE COMBUSTIBLES. OR PRODUCTS SUCH AS GASOLINE, SOLVENTS, PAINT THINNER, DUST PARTICLES OR UNKNOWN CHEMICALS.

 **WARNING:** NOT FOR HOME OR RECREATIONAL VEHICLE USE.

The heater is designed and approved for use as a construction heater in accordance with Standard ANSI Z83.7 CSA 2.14. CHECK WITH YOUR LOCAL FIRE SAFETY AUTHORITY IF YOU HAVE QUESTION ABOUT APPLICATIONS.

Other standards govern the use of fuel gases and heat producing products in specific applications. Your local authority can advise you about these.

 **WARNING**

The State of California requires the following warning:

 **WARNING:** COMBUSTION BY-PRODUCTS PRODUCED WHEN USING THIS PRODUCT CONTAIN CARBON MONOXIDE, A CHEMICAL KNOWN TO THE STATE OF CALIFORNIA TO CAUSE CANCER AND BIRTH DEFECTS (OR OTHER REPRODUCTIVE HARM).

Important Manual Information

To the owner

Thank you for choosing a Shizuoka Seiki infrared gas heater. This Owner's Manual contains information needed for proper operation, maintenance and care. A thorough understanding of these simple instructions will help you obtain maximum satisfaction from your new Shizuoka Seiki. If you have any questions about the operation or maintenance of your infrared gas heater, please consult with your Shizuoka Seiki dealer. If you have any questions or want to know more detailed information about the heater, please contact your dealer. If any irregular or missing pages are found in this Manual, please contact your dealer and we will replace them with new ones.

In this Owner's Manual, particularly important information is distinguished in the following ways.

DANGER

"DANGER" means that failure to follow the given precaution (s) may lead to death, serious injury and/or major fire.

WARNING

"WARNING" means that failure to follow the given precaution (s) may likely result in death, serious injury, fire and/or possible explosion.

CAUTION



"CAUTION" means that failure to follow the given precaution (s) may result in serious injury and/or property damage.

Depending on the circumstances, even the category of "CAUTION" can lead to grave damage to persons and/or property. Cautions and recommendations listed in each category are equally important for safe operation. Be sure to follow the precautions in all 3 categories.

POINT:

A POINT provides key information to simplify and clarify procedures.

The following signs, used throughout this Manual, are defined as follows:

	Prohibited (This indicates "actions that are strictly forbidden".)
	Mandatory (This indicates "actions or instructions" that must be carried out.)
	Caution (This indicates "actions" that require careful attention)

AS we cannot predict every possible dangerous situation while operating this heater, the contents described in this Manual cannot fully foresee the entire range of possible dangers. When operating the heater or carrying out daily inspection, please pay careful attention to the contents of this Manual and the Labels on the heater itself. In addition, be constantly alert for factors that might affect the safe operation of the heater. Do not hesitate to stop operation and contact your dealer if you have any questions about any matters not discussed in this Manual.

Important Manual Information

- Intended use is the temporary heating of buildings or structures under construction, alteration or repair.
- The installation shall conform with local codes or, in the absence of local codes, with the National Fuel Gas Code ANSI Z223.1/NFPA 54 and the National Gas and Propane Installation Code, CSA B149.1.
- The installation must conform with local codes or in the absence of local codes, with the Standard for the Storage and Handling of Liquefied Petroleum Gases, ANSI/NFPA 58 and the Natural Gas and Propane Installation Code, CSA B149.1.

Shizuoka Seiki is constantly striving to improve product design and quality. Therefore, although this manual contains the most current product information available at the time of printing, there may be minor discrepancies between your heater and this manual. If you have any questions concerning this manual, please consult your Shizuoka Seiki dealer.

POINT:

- This Manual aims to supply the user with detailed information on how to properly use, operate and service this VAL6 Heater.
- The VAL6 GN5, VAL6 GP5, and the standard equipment are used as the basis for explanations, pictures, and illustrations in this manual.

VAL6 GN5, VAL6 GP5
Owner's Manual
©2013 by Shizuoka Seiki Co., Ltd.
3rd edition, August 2015
All rights reserved. Any reprinting or
unauthorized use without the written permission
of Shizuoka Seiki Co., Ltd. is expressly
prohibited.
Printed in Japan
Parts Number 51001-200004B

Table of Contents

Location of Safety Labels	1
Safety Information	3
Specifications	8
Heater Specifications	8
Gas Requirement.....	8
Wiring Diagram	8
Main Components	9
Safety Devices	10
Operation.....	10
Gas Cylinder Installation	10
Hose Connection	10
Check Leakage	11
Adjusting the 2nd pressure for solenoid valve	11
Gas Cylinder Numbers for Operation.....	13
Adjust the Angle of Main Unit.....	14
Connecting the Power Supply.....	14
Operation Procedures.....	15
Ignition	15
Shut Off.....	15
Connecting the Control Device (Thermostat)	16
Heat Shielding Mat	16
Operation with Portable Generator	16
Maintenance	16
Filter Replacement.....	17
Storage	18
Trouble Recovery	18

Location of Safety Labels

- Safety labels provide important information for safe use of the heater. Do not remove or soil them.
- If any labels are illegible or have been removed, contact your dealer for replacements.

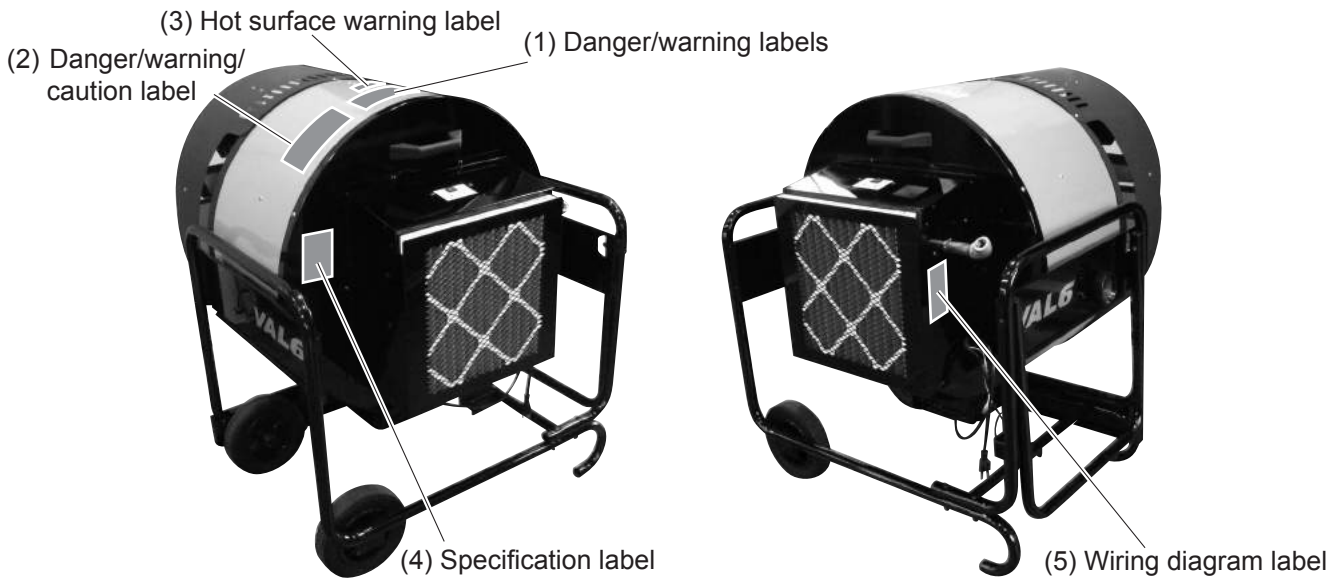

(1) Danger/warning labels

<p>WARNING/AVERTISSEMENT</p>	<p>WARNING/AVERTISSEMENT</p>	<p>DANGER/DANGER</p>	<p>DANGER/DANGER</p>
<p>Always unplug heater before servicing and checking. Débranchez systématiquement l'appareil de chauffage avant tout entretien et vérification.</p>	<p>Never touch heater until heater has cooled off. Ne touchez jamais l'appareil de chauffage tant qu'il n'a pas refroidi complètement.</p>	<p>Use heater only in well ventilated areas. Utilisez uniquement l'appareil de chauffage dans les endroits parfaitement aérés.</p>	<p>Never use heater where highly flammable vapors are present. N'utilisez jamais l'appareil de chauffage en présence de vapeurs inflammables.</p>
50300-201-023			

(2) Danger/warning/caution label

<p>⚠ Read Owner's Manual before using.</p>		<p>⚠ GENERAL HAZARD WARNING:</p> <p>FAILURE TO COMPLY WITH THE PRECAUTIONS AND INSTRUCTIONS PROVIDED WITH THIS HEATER, CAN RESULT IN DEATH, SERIOUS BODILY INJURY AND PROPERTY LOSS OR DAMAGE FROM HAZARDS OF FIRE, EXPLOSION, BURN, ASPHYXIATION, CARBON MONOXIDE POISONING, AND / OR ELECTRICAL SHOCK.</p> <p>ONLY PERSONS WHO CAN UNDERSTAND AND FOLLOW THE INSTRUCTIONS SHOULD USE OR SERVICE THIS HEATER.</p> <p>IF YOU NEED ASSISTANCE OR HEATER INFORMATION SUCH AS AN INSTRUCTIONS MANUAL, LABEL, ETC. CONTACT THE MANUFACTURER.</p> <p>⚠ WARNING: FIRE, BURN, INHALATION, AND EXPLOSION HAZARD. KEEP SOLID COMBUSTIBLES, SUCH AS BUILDING MATERIALS, PAPER, OR CARDBOARD, A SAFE DISTANCE AWAY FROM THE HEATER AS RECOMMENDED BY THE INSTRUCTIONS. NEVER USE THE HEATER IN SPACES WHICH DO OR MAY CONTAIN VOLATILE OR AIRBORNE COMBUSTIBLES, OR PRODUCTS SUCH AS GASOLINE, SOLVENTS, PAINT THINNER, DUST PARTICLES OR UNKNOWN CHEMICALS.</p> <p>⚠ WARNING: NOT FOR HOME OR RECREATIONAL VEHICLE USE</p> <p style="text-align: right;">>PET< 51001-203-032</p>					
<p>⚠ Danger</p>	<ul style="list-style-type: none"> • Never put anything on or cover radiation disk and protector at any time. • Never use the heater in an altitude higher than 1,000m (3,000ft) above sea level. 						
<p>⚠ Warning</p>	<ul style="list-style-type: none"> • Never repeat the switching on and off sequence more than 3 times. In case of problems, consult with your distributor. • Never use heater in the presence of flammable or volatile gas such as spray cans. • Use only in places free of flammable vapors and excessive dust, such as found in chips and waste paper. • Never operate heater unattended. 						
<p>⚠ Caution</p>	<ul style="list-style-type: none"> • Keep heater away from flammable materials, maintaining a distance of at least 8.2 feet (2.5 meters). • Do not use heater in places exposed to rain, snow or high temperatures. • Should only be used with non-combustible flooring. • Never move heater while in operation. • Heater may still be hot after it is turned off. • Immediately discontinue use of the heater in case of any irregularities. • Make sure the operating lamp is off before removing the electric plug. • Be sure to properly position heater prior to use. • For indoor use only. Adequate ventilation must be provided at all times. • The hose assembly should be protected from traffic, building materials and contact with hot surfaces both during use and while in storage. • Never touch or adjust the air intakes of the burner fan motor. • To avoid severe burns and electrical shock, never adjust the angle of the main unit while the heater is plugged in, operating, or still hot. • Be sure to take hold of the burner grip when setting the angle of the main unit. • Be sure to attach the filter prior to operation. 						
<p>Operation</p>	<table border="1" style="width: 100%;"> <tr> <td style="text-align: center;">LAMP</td> <td style="text-align: center;">MEAN/ACTION</td> </tr> <tr> <td style="text-align: center;">RUN (GREEN)</td> <td style="text-align: center;">AIRPURGE OR FIRING, COOLING</td> </tr> <tr> <td style="text-align: center;">MISFIRE (RED)</td> <td style="text-align: center;">MISFIRE, FUEL EMPTY OR AIR.</td> </tr> </table> <ul style="list-style-type: none"> • Turn operation switch on. Combustion will start in about 15 seconds. • If the heater fails to ignite, turn switch off and on again. • Turn operation switch off. Combustion stops • The operation lamp and blower remain ON for 5 minutes after turning the switch off, and then stop automatically. 		LAMP	MEAN/ACTION	RUN (GREEN)	AIRPURGE OR FIRING, COOLING	MISFIRE (RED)
LAMP	MEAN/ACTION						
RUN (GREEN)	AIRPURGE OR FIRING, COOLING						
MISFIRE (RED)	MISFIRE, FUEL EMPTY OR AIR.						
<p>WARNING Electrical Grounding Instructions This appliance is equipped with a three-prong (grounding) plug for your protection against shock hazard. It should be plugged directly into a properly grounded three-prong receptacle.</p>							

Location of Safety Labels

(3) Hot surface warning label



(4) Specification labels

VAL6GN5	
OUTPUT Puissance de sortie	144000BTU/h
FUEL CONSUMPTION Consommation de combustible	137CFH, 6.1lbs/h
FUEL Combustible	Natural gas
POWER CONSUMPTION Puissance consommee	107W with ignition spark/a l'allumage 93W with combustion/en combustion
ELECTRIC REQUIREMENTS / Conditions electriques	230V 50Hz phase 1
Inlet Gas Pressures / Pressions de gaz d'entree	5 ~ 7 inch.w.c.
Manifold Pressures / Pression du collecteur	1.8 inch.w.c.
① SERIAL NO. 51001- Numero de serie Gas Fired Infrared Construction Heater ANSI Z83.7-2011, CSA 2.14-2011 Shizuoka Seiki Co., Ltd. Fukuroi, Shizuoka, Japan <small>The requirements of local authorities having jurisdiction shall be followed. Les conditions imposees par les autorites locales ayant jurisdiction doivent etre suivies.</small> Made in Japan	

VAL6GP5	
OUTPUT Puissance de sortie	144000BTU/h
FUEL CONSUMPTION Consommation de combustible	55.8CFH, 6.6lbs/h
FUEL Combustible	Propane gas
POWER CONSUMPTION Puissance consommee	107W with ignition spark/a l'allumage 93W with combustion/en combustion
ELECTRIC REQUIREMENTS / Conditions electriques	230V 50Hz phase 1
Inlet Gas Pressures / Pressions de gaz d'entree	10 ~ 11 inch.w.c.
Manifold Pressures / Pression du collecteur	1.5 inch.w.c.
① SERIAL NO. 51002- Numero de serie Gas Fired Infrared Construction Heater ANSI Z83.7-2011, CSA 2.14-2011 Shizuoka Seiki Co., Ltd. Fukuroi, Shizuoka, Japan <small>The requirements of local authorities having jurisdiction shall be followed. Les conditions imposees par les autorites locales ayant jurisdiction doivent etre suivies.</small> Made in Japan	

① SERIAL NO. is required for consulting with your dealer.



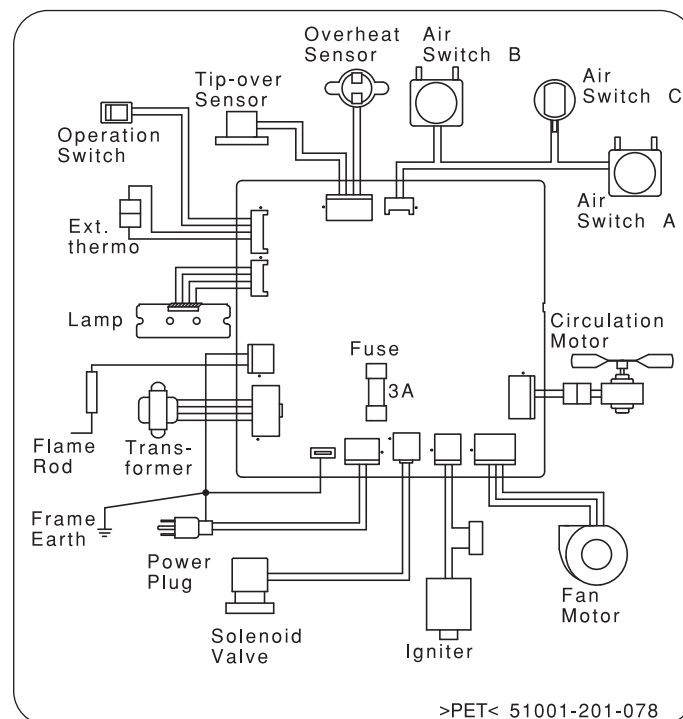

(5) Wiring diagram label















Safety Information

⚠ To Help Ensure Safe Operation, Comply with the Following Precautions















It is important that the safety precautions listed below are understood and followed prior to initial operation of the heater. These precautions must also be followed thereafter.

⚠ DANGER		
	Use proper gas for the heater	Use proper gas for the heater as described below. VAL6 GN5 = Natural GAS VAL6 GP5 = Propane GAS Check the specifications on your heater before using the heater.
	Use of flammables prohibited	Never use or store the heater where thinner, gasoline, liquid propane gas, or other highly flammable vapors, etc., are present, because these may lead to explosion or fire.
	Ventilation required	Never use the heater in poorly ventilated areas. Poor ventilation allows a buildup of carbon monoxide produced by the heater, especially if there is also inadequate combustion. CARBON MONOXIDE is a colorless and odorless poisonous gas that can cause death or injury. Always provide a fresh supply of external or circulating air whenever the heater is being used. Some persons are more affected by carbon monoxide than others, including pregnant women, persons with heart disease, lung disease, anemia, and/or under the influence of alcohol. High altitude also creates a higher danger of susceptibility to carbon monoxide. Danger signs that a person may be suffering from carbon monoxide poisoning include headache, dizziness, burning eyes and nose, nausea, and dry mouth or sore throat. If any of these symptoms occur, immediately seek medical attention, ventilate the area, and turn the heater off.
	Avoid severe fire	To prevent fire or unexpected accident, never put anything on or cover the radiation disk and protector.
	Do not use the heater at high altitudes	Never use the heater at an altitude higher than 3,000 ft. (1,000 m) above sea level as this may cause production of carbon monoxide by the heater due to insufficient oxygen.











Safety Information

 WARNING		
	Follow all instructions in Owner's Manual	When operating or servicing this heater, please follow all instructions described in this Manual.
	Use only genuine parts	When replacing parts, use only the genuine parts made or approved by Shizuoka Seiki. Please note that we shall not be held responsible or liable for any damage or accident that results from using any unapproved or non-genuine parts.
	Liability or responsibility	We shall not be held liable or responsible for any damage or accident that results from disobeying or not properly carrying out any instructions in this Manual, or from the improper modification or operation of the heater.
	Keep aerosol containers away from the heater	Never place sealed, pressurized containers (such as aerosol cans) near the heater as exposure to heat from the heater may build up pressure in the container and cause it to explode with deadly force.
	Never use the heater where flammable dusts are present	Never operate the heater where highly flammable dusts (of wood, paper, textiles, etc.) are present. Dusts sucked and heated by the heater can be blown out in a "sparked" state and cause a fire.
	Be careful of hot surfaces on and around the heater	Some sections of the heater (both while the heater is in operation and for 30 minutes or more after the heater is turned off) are hot to the touch and may burn the skin and/or ignite clothing and other combustible materials. Avoid touching the burner and nearby areas while the heater is in operation and for at least 30 minutes after it is turned off. Also do not move or service the heater while it is operating or hot.
	Do not service the heater while burning	To avoid any injury and/or trouble, do not service or handle the heater while burning, in operation, hot or plugged in.
	Modification of the heater prohibited	Never modify the heater by any means. Any modification may increase the chance of burns, fires, explosions, or other problems before, during, and after operation of the heater.
	Be careful of electrical shock	To avoid electrical shock, never use the heater where exposed to rain, snow or high humidity. If the heater or any part of it becomes immersed in water, immediately contact a Shizuoka Seiki dealer to inspect the heater and determine if anything needs to be replaced prior to further operation. Make sure the power plug is disconnected from the electrical outlet before starting daily inspection and maintenance.
	Never use the heater in households	This heater is for industrial use only. Never use the heater in households. Wrong use of this heater can result in potential death, serious injury, fire and/or possible explosion.
	Insure safe operation and carry out regular inspection	When operating or carrying out daily inspection (of this heater), please pay careful attention not only to the contents of this Manual and the Labels on the heater itself, but also be constantly alert for factors that might affect the safe operation of the heater.
	Be sure to warn anyone who works around or comes near the heater	The operator of the heater is responsible for warning anyone who works around the heater or comes near the heater of possible dangers and the safety precautions that must thereby be taken pursuant to this Manual.









Safety Information

 CAUTION		
	Keep flammable materials away from the heater	To prevent fires, please keep all flammables more than 8.2 ft. (2.5 m) away from the front of the radiation disk, and more than 6.6 ft. (2 m) away from all sides (left/right and top/rear) of the heater.
	Do not block the heater	To prevent fires, never place any object within 3.3 ft. (1 m) from (the front of) the radiation disk. The flow of combustion and ventilation air should not be obstructed.
	Do not try to ignite the heater more than 3 times in a row	If the heater does not ignite the first time, do not try to ignite more than 2 more times in a row thereafter, as this could result in a fire. If the heater does not ignite after the third attempt, make no further attempts and consult your dealer prior to further operation of the heater.
	Do not operate the heater unattended	In order that unexpected problems, such as fire, can be dealt with immediately, do not leave the heater unattended while it is in operation or cooling down.
	Placing the heater on combustible matter or flooring is prohibited	The heater is only intended for use on non-combustible matter or flooring unless the shielding mat, part #503002-05001 is used. Shielding mat materials : glass cloth and aluminum film Shielding mat dimensions : 1200 x 1200 x (3.5) mm (L x W x H)
	Operation of the heater when either the heater or the operator is wet is prohibited	Do not use the heater where it is exposed to water, e.g., rain or snow, and do not operate the heater with wet hands or if it becomes wet. Water contact may cause electrical shock or other danger or malfunction.
	Discontinue use of the heater if anything irregular is discovered	If a burning smell or smoke occurs during operation of the heater, immediately turn off the heater and consult your dealer. Further operation may result in a fire or other hazard.
	Do not move the heater while in operation	Moving the heater while it is on or otherwise in operation is prohibited. Movement may result in a fire, especially if the heater is overturned or unbalanced.
	Turn the heater off before unplugging it	Before taking the electric plug out of the outlet, please make sure the operating lamp is OFF.
	Use only the correct voltage	To prevent fire, electrical shock and/or damage, only the electrical voltage and frequency specified on the model plate should be used.
	Ground the heater before operation	Prior to operation, confirm that the heater is properly connected to a grounded power cord and outlet. Attempting to use or operate the heater without proper grounding may result in dangerous electrical shock.
	Do not pull out the power plug by pulling on the power cord	When disconnecting the power cord, always pull on the plug, never on the cord, to unplug the cord. Pulling on the cord may damage the cord itself and result in fire through electrical shock or short circuit.
	Do not damage the power cord	Do not place excessive force on the cord by bending, pulling, twisting, pinching or remodeling it. Also, to avoid fire and electrical shock, do not place any heavy objects on the heater, etc. that may damage it.
	Use gloves	When cleaning the heater, use gloves to avoid any injury to hands or fingers. Use of gloves is also recommended while operating and moving the heater.

Safety Information

 CAUTION		
	<p>Make sure the flame is extinguished and the power off before leaving the heater unattended</p>	<p>After shutting off the heater, make sure that the flame is extinguished and the power disconnected before leaving the heater unattended. It is also not safe to leave the heater unattended while it is cooling off or to leave it in any area where children are present or could come near the heater.</p>
	<p>Do not dispose of the heater illegally</p>	<p>When disposing of the heater, please do not dispose of it illegally, but consult your local authorities or specialists on how to properly dispose of it.</p>
	<p>Do not use the heater in the following places or conditions</p>	<p>To prevent accident or injury, do not use the heater in the following places or under the following conditions:</p> <ul style="list-style-type: none"> • On vibrating, trembling, or unstable flooring • On ladders, scaffolds, or sawhorses • On any floor that is slanted, sloped, or not level • On stairs or anywhere where it might block access to emergency exits • Near unstable or stacked materials • In windy, humid, or dusty areas, and areas where metal particles are present • In areas where the flow of people or vehicles is impeded or obstructed <p>Always use caution in determining where to place the heater for use or storage and take into account both present and potential future dangers.</p>
	<p>Do not use the heater in an environment subject to corrosive gas.</p>	<p>Do not use the heater in an environment subject to corrosive gas. Parts can become corroded and cause unit to operate improperly.</p>
	<p>Do not operate in extreme temperatures</p>	<p>Make sure that the heater operates at temperatures between 14 °F and 86 °F (-10 °C and 30 °C). If the heater operates at more than 86 °F (30 °C), the heater will overheat and could cause a fire.</p>
	<p>Transfer the Owner's Manual to the new owner</p>	<p>If the heater is sold or given to a new owner, make sure that this Owner's Manual is transferred to the new owner along with the heater.</p>
	<p>Keep away from children</p>	<p>The heater should not be used, cooled, or stored where children could have access to it. The heater should not be ignited, operated, maintained, attended to, or otherwise used in any way by children.</p>
	<p>Children or the handicapped are not to operate this heater</p>	<p>This heater is not to be operated by children or the physically handicapped or persons lacking proper knowledge and experience unless they have been given proper supervision or instruction.</p>
	<p>Never look directly into the radiation disk</p>	<p>While the heater is in operation, avoid looking directly into the radiation disk as this could cause eye injury.</p>
	<p>Hose assembly must be inspected before each use</p>	<p>The hose assembly should undergo visual inspection prior to each use of the heater. If excessive abrasion or wear is evident, or the hose is cut, the hose assembly must be replaced prior to operation of the heater. The replacement hose assembly should be equipment specified by Shizuoka Seiki.</p>

Safety Information

 CAUTION		
	Keep the heater away from propane gas containers	The heater, other than a heater with an integral propane gas container, must be located at least: (i) 6 ft. (1.83 m) in the U.S. or (ii) 10 ft. (3 m) in Canada, from any propane gas container. Each heater shall be supplied with a gas hose assembly neither less than 15 ft (5 m) nor more than 50 ft (16 m) in total length in Canada. And neither less than 10 ft (3 m) nor more than 25 ft (8 m) in total length in US.
	Pay attention to direction of heater	Blower or radiant type heaters shall not be directed toward any propane-gas container within 20 ft. (6 m).
	Arrange for the cylinder supply system	The cylinder supply system should be arranged for in order provide vapor withdrawal from the operating cylinder.
	Be sure to shut off the gas supply when not using heater	The gas should be turned off at gas supply cylinder/line when the heater is not in use.
	Be sure to disconnect the cylinder and heater when not using heater	If the heater is to be stored indoors, the connection between the propane supply cylinder and the heater must be disconnected, and the cylinder removed from the heater and stored in accordance with Standards for the Storage and Handling of Liquefied Petroleum Gases, ANSI/NFPA 58 and Natural Gas and Propane Installation Code, CSA B149.1.
	Adjusting an air intake is prohibited	Never touch or adjust an air intake of burner fan motor because the amount of air intake for the heater is sensitive. Doing so may cause trouble in the heater.
	Use burner grip when adjusting angle of heater	To avoid major burn injury, be sure to take hold of the burner grip when setting the angle of the main unit.
	Attach the filter prior to operation	Failure to attach the filter prior to operation will cause dust to accumulate in the burner section causing a shortage in air combustion, triggering the safety device to stop combustion.

Main Components

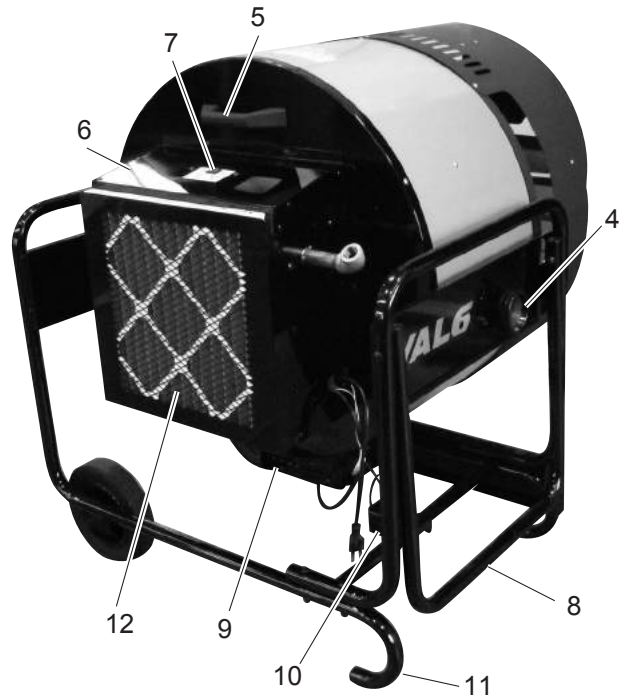

- 1 Radiation disk
- 2 Protector
- 3 Wheel
- 4 Knob bolt

- 5 Burner grip
- 6 Burner cover
- 7 Switch section
- 8 Handle

- 9 Blower
- 10 Tip-over switch
- 11 Legs
- 12 Filter

Burner Section

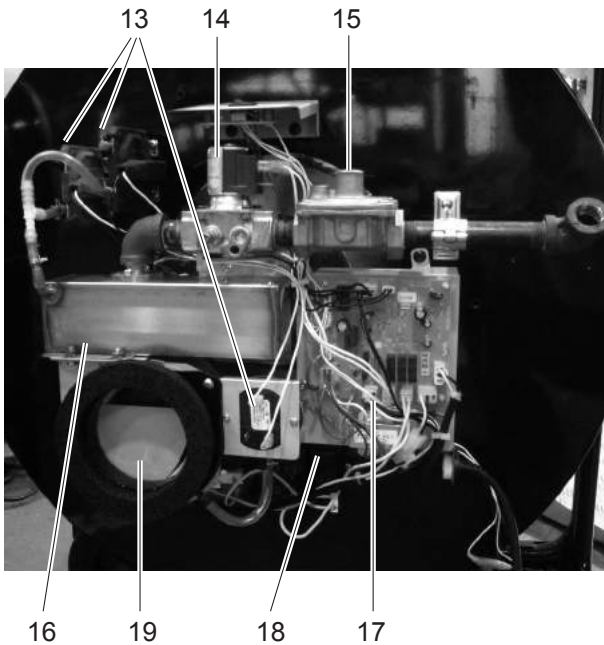

- 13 Air switch
- 14 Solenoid valve
- 15 Regulator
- 16 Gas mixing box

- 17 Fuse
- 18 Ignition transformer
- 19 Combustion fan

Switch Section

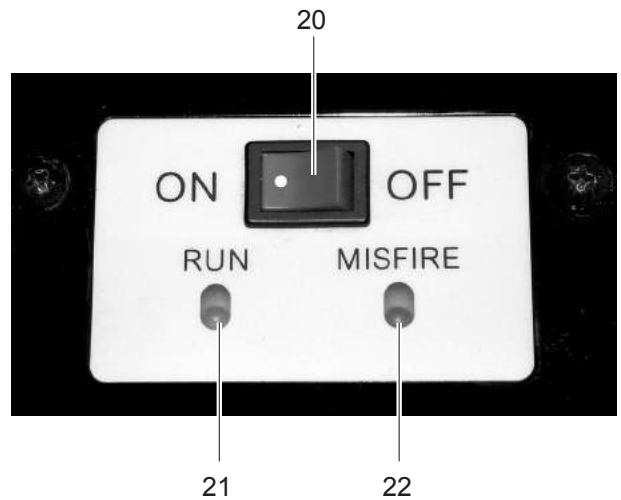

- 21 Operating lamp
- 22 Misfire lamp

Safety Devices

Description of Safety Devices	
Overheat protection	Automatically extinguishes the flame if the heater overheats. Operating condition: Misfire lamp lights and the post purge sequence runs for about 5 minutes if the heater is in operation.
Electric overload system (Fuse)	This shuts off the power supply in case of excessive electric current due to problems with the devices. Operating condition: The entire operation stops.
Tip-over switch	Automatically extinguishes the flame when motion or an impact is detected during operation. Operating condition: Misfire lamp lights and the post purge sequence runs for about 5 minutes if the heater is in operation.
Air switch	Automatically extinguishes the flame if the combustion fan stops, the burner is clogged with dust, or the filter is clogged with dust. Operating condition: Misfire lamp lights and the post purge sequence runs for about 5 minutes if the heater is in operation.

Operation

Gas Cylinder Installation

POINT:

- The installation must conform with local codes or, in the absence of local codes, with the Standards for the Storage and Handling of Liquefied Petroleum Gases, ANSI/NFPA 58 and the Natural Gas and Propane Installation Code, CSA B149.1.
- Regulator must be installed at outlet of cylinder of propane gas and input gas pressure have to be 11" w.c.

Hose Connection

- All hose connections must be made using a wrench to tighten the fitting.
- Be sure that the cylinder valve is closed when connecting or disconnecting the cylinder.
- Use the hose provided by the manufacturer as an accessory.

Hose to Heater Propane Supply Valve



Propane Tank Regulator



Hose (1/2NPT male) must be fixed tightly to joint connection (1/2NPT female) of the heater with wrench as pictured. Be sure to use seal material and no leakage there.

Operation

Check Leakage

- Check all connections for leaks. Apply a soap and water solution to all connections and check for bubbles. If any leaks are detected, retightening of connections is required immediately.
- Shut off the gas supply valve before refastening the connections.
- After repairing the leaks, retry to check connections for leaks with a soap and water solution.

WARNING

Do not touch or adjust a brass pipe on solenoid valve. This is intended for maintenance person to check the manifold pressure. If it is made any adjustment improperly, gas leakage may occur.

Adjusting the 2nd pressure for solenoid valve

CAUTION

Failure to adjust the 2nd pressure for solenoid valve causes incomplete combustion during operation, thereby triggering the safety device to stop combustion.

After checking for leakage, be sure to adjust the 2nd pressure (gas pressure) for manifold of solenoid valve prior to operation.

1. Remove the burner cover. Open the pressure checking port of solenoid valve by turning counterclockwise with a flathead screwdriver.

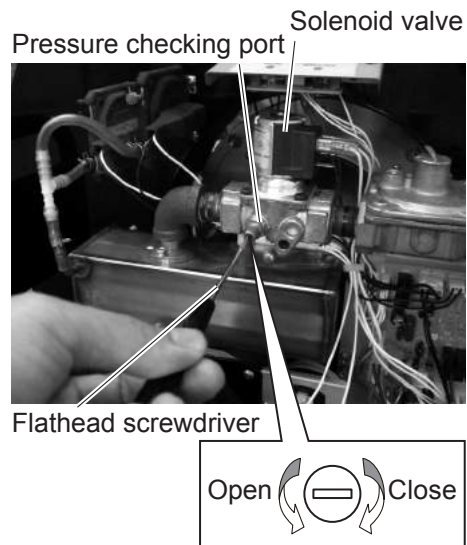

2. Connect a pressure gauge to the pressure checking port (9 mm in outside diameter) by using a tube (6 to 8 mm in inside diameter).

POINT:

Recommended pressure gauge
MAX range: 500 Pa (2 inches w.c.)

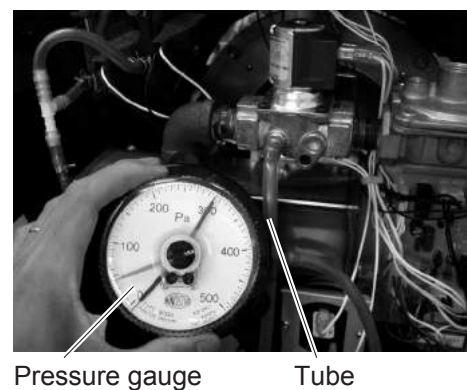

Operation

3. Start the combustion operation. (Refer to Ignition on page 15.)

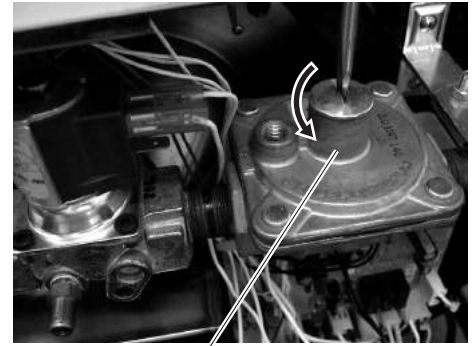

Regulator

4. Loosen and remove the top cap of the regulator, and adjust the 2nd pressure with a Phillips screwdriver.

Clockwise: To raise pressure

Counterclockwise: To reduce pressure

POINT:

GN5: 1.8 inches w.c. (435 Pa)

GP5: 1.5 inches w.c. (375 Pa)



Phillips screwdriver



5. Stop the operation after adjustment. Then, be sure to cap the regulator and close the pressure checking port of solenoid valve. Be fully aware that failure to properly close causes leakage of gas. Preparations for starting operation are complete when you re-attach the burner cover.

Operation

Gas Cylinder Numbers for Operation

Vaporization Rate

100 LB Propane Cylinders (approximate)

Maximum continuous draw in BTU per hour at various temperatures expressed in Fahrenheit.

This heater cannot be used at less than 144,000 BTU, thus keep supplied amount at over 144,000.

Lbs. of Propane in Cylinder	20 degree F (-6.7 °C)		
	1 Tank	2 Tanks	3 Tanks
100	167,000	367,000	807,000
90	152,000	334,000	734,000
80	137,000	301,000	662,000
70	122,000	268,000	589,000
60	109,000	239,000	453,000
50	94,000	206,000	382,000
40	79,000	174,000	319,000
30	66,000	145,000	319,000
20	51,000	112,000	246,000
10	38,000	84,000	184,000

INFORMATION ON SIZE * CAPACITY OR PROPANE GAS CYLINDERS:

The chart below shows the number and size of propane tanks needed to run this heater.

*Less gas is vaporized at lower temperatures.

You may need 2 or more 100 pound tanks or one larger tank in colder weather.

Temperature (°F) At tank	Number of Tanks
	150,000 BTU/h
Above 32 °F (0 °C)	2 - 100 lb
32 °F (0 °C)	2 - 100 lb
20 °F (-6.7 °C)	3 - 100 lb

POINT:

Be sure to use a cylinder with vapor withdrawal.

Operation

Adjust the Angle of Main Unit

CAUTION

- To avoid severe burns and electrical shock, do not adjust the angle of the main unit while the heater is plugged in, operating, or hot.
- To avoid major burn injury, be sure to take hold of the burner grip when setting the angle of the main unit.

Prior to operation, loosen the knob bolt to move and set the main heater unit at the desired angle, and then tighten the knob bolt firmly. The vertical angle of the radiation disk is adjustable up to 90 degrees.

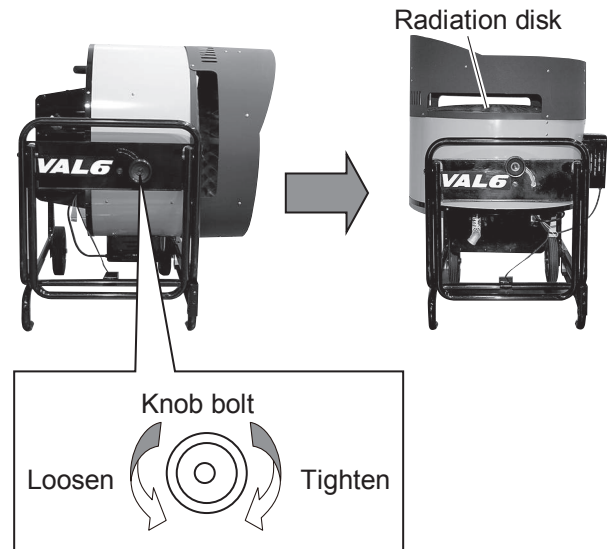

Connecting the Power Supply

CAUTION

Do not use an adapter to change the power plug or power outlet from grounded (3 prongs or inlets) to ungrounded (2 prongs or inlets) as this improperly overrides the safety function in grounding the heater by means of the provided power plug. Also, if the power cord or plug needs to be replaced, replace only with genuine or Shizuoka Seiki-approved replacement parts.

1. Make sure that the operating switch is "OFF" and then plug the heater's power plug into an approved, grounded, 3-wire extension cord.
2. Plug extension cord into standard 230 volt/50 Hz, 3-prong grounded outlet.

POINT:

Extension Cord size Requirement

- 6 to 10 feet (1.8 to 3 meters) long, use 18 AWG (0.75 mm²) rated cord
- 11 to 100 feet (3.3 to 30.5 meters) long, use 16 AWG (1.0 mm²) rated cord

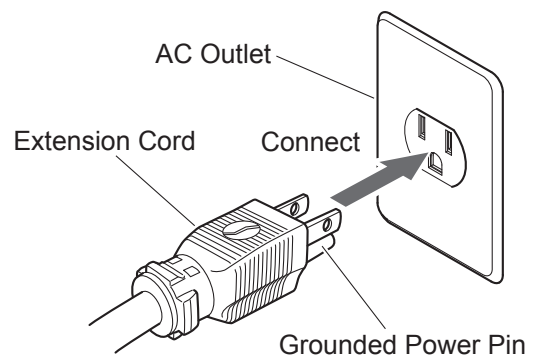

Operation

Operation Procedures

CAUTION

- If you detect smoke or a burning smell coming from the heater, turn the heater off immediately to prevent a fire, and contact your dealer to have the heater inspected prior to further operation.
- If the heater does not ignite the first time, do not try to ignite more than 2 more times in a row thereafter, as this could result in a fire. If the heater does not ignite after the third attempt, make no further attempts and consult your dealer prior to further operation of the heater.
- When using the heater, be careful that the floor surface (in front of it) does not become overheated.

Ignition

POINT:

To make sure the heater is ignited, do not leave the heater until you confirm that it is burning and otherwise functioning properly.

1. Turn the operating switch "ON". The operating lamp will light and the heater will ignite in about 15 seconds.



If ignition fails, try again as follows

Stop operation completely. Wait for the operating lamp to turn off. After the operating lamp has turned off, attempt ignition again. **DO NOT TRY TO IGNITE THE HEATER MORE THAN 3 TIMES IN A ROW AS FIRE MAY RESULT.**

Shut Off

CAUTION

After operation has stopped, make sure that the flame is completely extinguished before leaving the heater unattended or moving or storing it.

POINT:

- Before you disconnect the power plug from the AC outlet, make sure that the combustion fan is stopped.
- Never disconnect the power plug while the heater is operating as this will cause unexpected problem such as burn injury.
- Regarding a heater for propane (GP5), turned off at the propane supply cylinder(s).

1. Turn "OFF" the operating switch, and the heater flame will be extinguished, then the cooling operation will also automatically stop after about 5 minutes, and finally the operating lamp will turn off.
2. Be sure to shut off main gas supply valve after using the heater.



Operation

Connecting the Control Device (Thermostat)

1. Uncouple the terminals (A) attached to the tips of the white wires coming out of the right side of the burner cover.
2. Connect both the male and female terminals, which are uncoupled, to the connectors (B) of the control device.

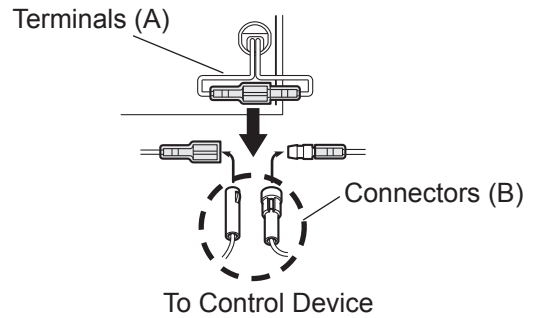

CAUTION

- If the heater is controlled by another device (such as a thermostat or a timer), the heater could turn itself on at any time.
- When the heater is controlled by another device, extra care must be taken to ensure that the heater is not accidentally turned on without someone nearby who can immediately attend to any problems when the heater is ignited, operating, and cooling off.

Heat Shielding Mat

To avoid unexpected fire or trouble, NEVER use the heater on combustible flooring unless the heat shielding mat, which is available as an option, is used.



Operation with Portable Generator

WARNING

Before operating the heater from a portable generator, please confirm that the generator has been properly connected to the ground earth. Operating the generator without proper grounding may result in electrical shock. Please refer to the owner's manual supplied by the manufacturer of the generator.

The heater operates within the voltage range between 207 Volts and 253 Volts. Before plugging the heater into the generator, the output voltage of the generator should be verified.

If the voltage does not measure in this range, the heater should not be plugged into the generator.

Maintenance

WARNING

- Do not repair or service the heater if you have not been trained in repair and service of natural and propane gas heaters. Maintenance should only be carried out by authorized persons.
- To avoid any injury and/or trouble, never inspect or service the heater while it is burning, in operation, hot or plugged-in.
- Make sure to close all gas supply valves before service of heater unit.

Maintenance

CAUTION

- Before starting any inspection or service, to avoid electrical shock, please make sure the heater is shut down and that the power cord is disconnected.
- When cleaning the heater, please wear gloves to prevent possible injury.
- Do not use a pressure washer for cleaning the heater.

1. All gas supplies must be closed before maintenance.
2. Before using, the heater must be cleaned using compressed air, a soft cloth or brush.
3. Be sure to check all gas connections with a soap and water solution.

Filter Replacement

CAUTION

- Be sure to attach the filter prior to operation. Failure to do so will cause the burner to get clogged, causing unit to operate improperly.
- Use the recommended replacement filter, Airflow products company MERV8 AFP2000.

1. Remove the screws (1 screw per side), pull out the filter cover by pulling away from the unit, and then remove the filter by sliding it upward.

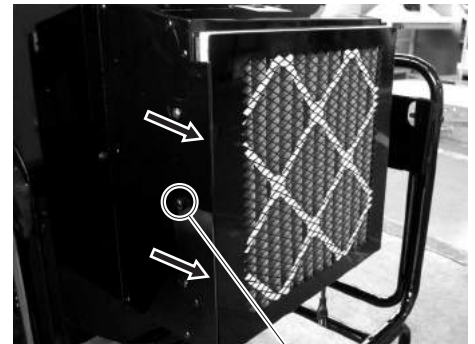

Screw

2. Attach the filter with arrow on filter pointing towards unit. (as shown in picture)

POINT:

The filter should be attached with its folds aligned vertically.



Air Flow

3. Secure the filter cover with the screws.

CAUTION

Be sure to secure the filter properly with the screws. If filter is not secured with the screws, dust will enter from the gaps between the main unit and the filter, the burner to clog, resulting in the unit to operate improperly.

Storage

CAUTION

If the heater is stored or not used for an extended period of time, shut off the main valve for natural/propane gas and disconnect the gas hose.

When storing the heater, please disconnect the power plug from the extension cord and/or the AC outlet and store the heater indoors where it is less humid.

Trouble Recovery

POINT:

In case of problems with your heater, please refer to this checklist before consulting with your dealer.

Please contact your dealer if results are not satisfactory even after referring to the table, or you have problems not described in this table. When consulting with your dealer, please describe the problem you have, also mentioning the model name and serial number of your heater.

(To find the heater's serial number, please refer to page 2.)

Phenomenon	Possible Cause	Remedy
The heater does not start. (The lamp does not light up.)	Power cord is not connected with an AC outlet. Power supply is cut off.	Please connect the power cord with an AC outlet, and check the power supply.
	Blown fuse	Replace fuse with a new one.
The heater does not ignite.	No gas supply.	Please check all gas connections and confirm that valves have been opened.
	The filter is clogged.	Replace the filter. Be sure to attach the filter prior to operation.
The flame goes out during operation.	No gas supply.	Check if there is any fuel in the cylinder and replace if missing.

Phenomenon	Explanation
Smoke or odors from heater when used for the first time.	This is because fuel is burning together with dust, etc. This phenomenon will disappear after a short while.
Noise from burner section during heater ignition or shut-down.	Noise is caused by expansion or shrinkage of the burner section due to temperature fluctuations. This is not an irregularity.

Schematic diagram for VAL6 GN5 / GP5

